

Specification

Aluminium 6063-T6 alloy to BS EN 755-9 standard, powder coated to BS 6496 to 60 - 80 micron finish.

Aluminium Finish: White - RAL 9003 Satin.

Sub-Frame: Primed high quality with 2 coats, FSC Mix credit radiata pine clear grade, FSC mix credit TT-COC-002 157.

Timber Size: 25mm x 16mm.

Glazing: All frames are factory glazed.
(8.8-10.8 single glazed).

Gasket colour: White.

Trim: 27mm uPVC Single Bullnosed White.

Ironmongery: Butt hinges as standard.
Flat pendant handle as standard, locking turnbuckle as a option.

Orientation: Left hand and right hand options.

In line with our company policy of continuous product development and improvement, Granada reserves the right to make minor alterations to specification without notice.

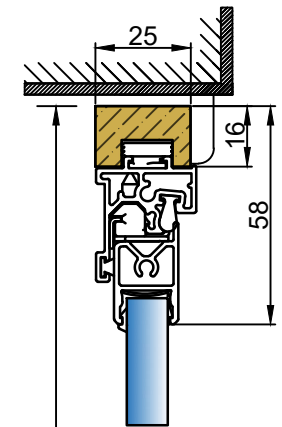

Frame Height

Section A-A

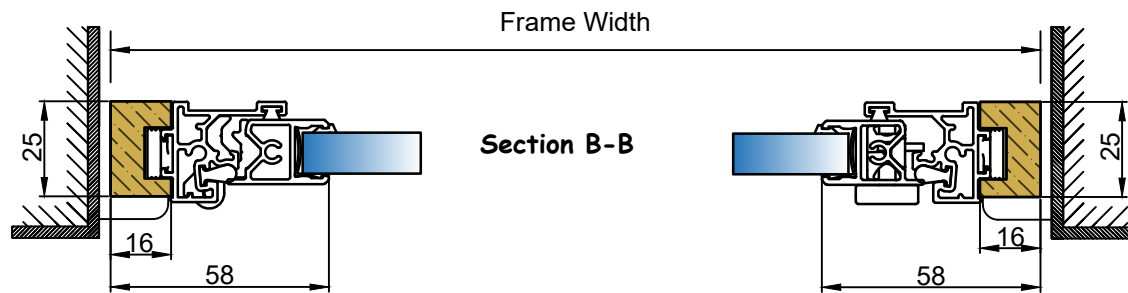

Frame Width

Section B-B

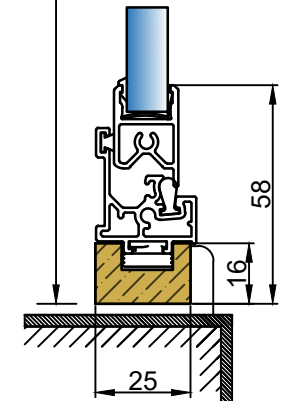

PROJECT:
Standard Details

GSG_001
DRAWING NO.

-
PROJECT NO. 07/07/21
DATE.

TITLE:
HU-SL-R Hinge unit, Reveal Fix, upto 10.8mm glass

NTS
AB
DRAWN.

RH
CHECKED.
REVISION.



Campbell Way
Dinnington
Sheffield
S25 3QD
Tel: 01909 499 899
W: www.granadaglazing.com

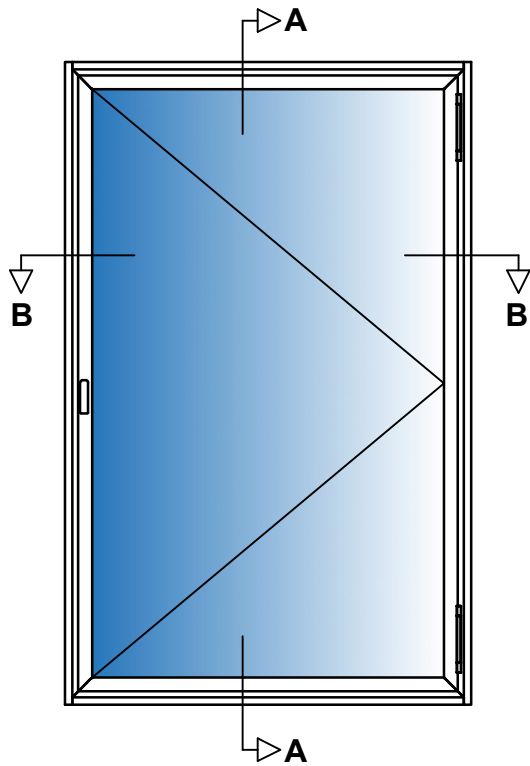

Specification

Aluminium 6063-T6 alloy to BS EN 755-9 standard, powder coated to BS 6496 to 60 – 80 micron finish.

Aluminium Finish: White – RAL 9003 Satin.

Sub-Frame: Primed high quality with 2 coats, FSC Mix credit radiata pine clear grade, FSC mix credit TT-COC-002 157.

Glazing: All frames are factory glazed.
(8.8-10.8 single glazed).

Gasket colour: White.

Trim: 27mm uPVC Single Bullnosed White.

Ironmongery: Butt hinges as standard.
Flat pendant handle as standard, locking turnbuckle as a option.

Orientation: Left hand and right hand options.

In line with our company policy of continuous product development and improvement, Granada reserves the right to make minor alterations to specification without notice.

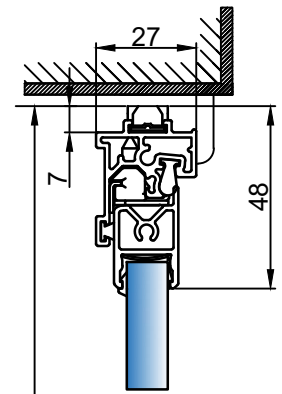

Frame Height

Section A-A

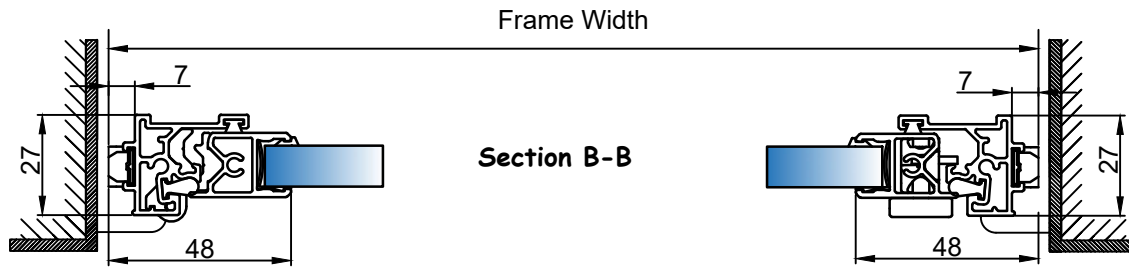

Frame Width

Section B-B

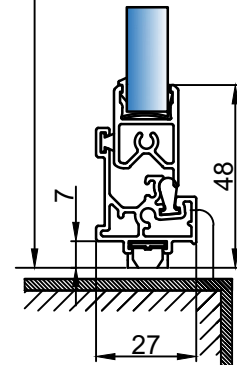

PROJECT:
Standard Details

GSG_001
DRAWING NO.

-
PROJECT NO. DATE.

07/07/21

TITLE:
HU-SL-R Hinge unit, No sub reveal Fix, upto 10.8mm glass

NTS
AB
DRAWN.

RH
CHECKED.

-
REVISION.



Campbell Way
Dinnington
Sheffield
S25 3QD
Tel: 01909 499 899
W: www.granadaglazing.com

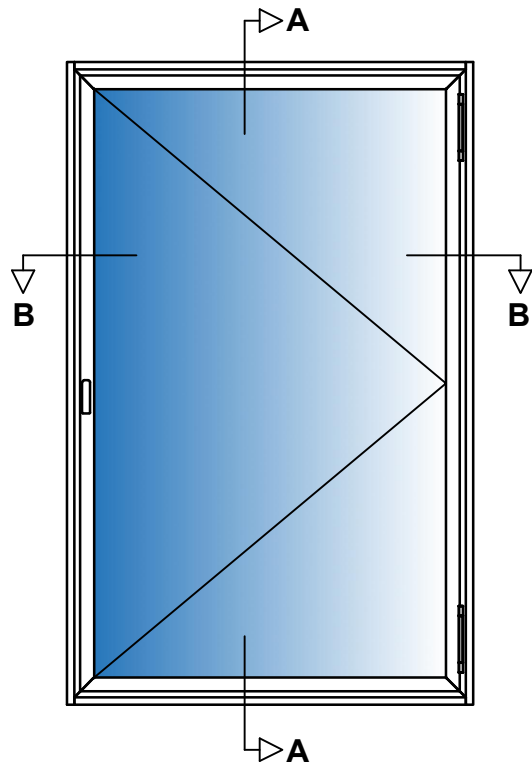

Specification

Aluminium 6063-T6 alloy to BS EN 755-9 standard, powder coated to BS 6496 to 60 - 80 micron finish.

Aluminium Finish: White - RAL 9003 Satin.

Sub-Frame: Primed high quality with 2 coats, FSC Mix credit radiata pine clear grade, FSC mix credit TT-COC-002 157.

Timber Size: 25mm x 16mm.

Glazing: All frames are factory glazed.
(8.8-10.8 single glazed).

Gasket colour: White.

Trim: 27mm uPVC Single Bullnosed White.

Ironmongery: Butt hinges as standard.
Flat pendant handle as standard, locking turnbuckle as a option.

Orientation: Left hand and right hand options.

In line with our company policy of continuous product development and improvement, Granada reserves the right to make minor alterations to specification without notice.

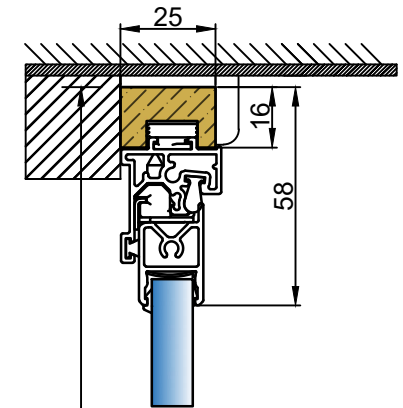

Frame Height

Section A-A

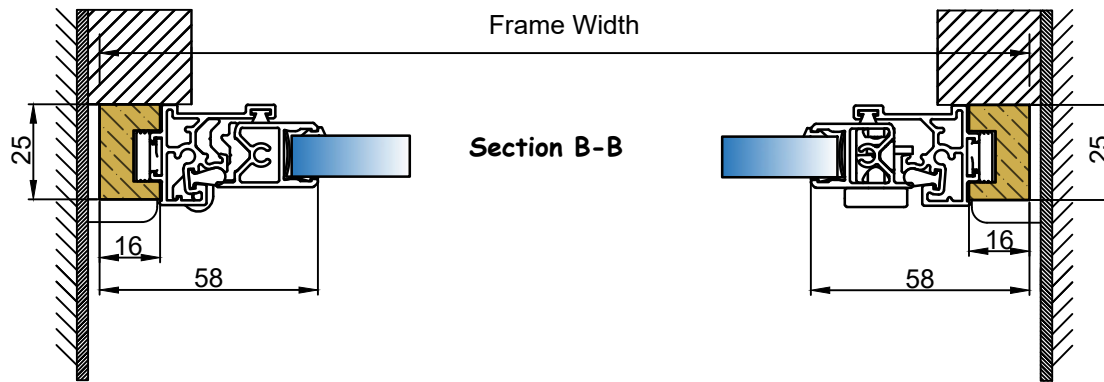

Frame Width

Section B-B

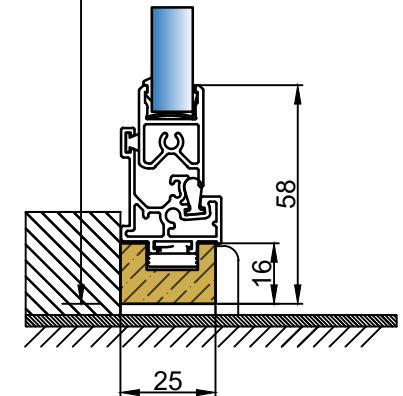

PROJECT:
Standard Details

GSG_001
DRAWING NO.

-
PROJECT NO. 07/07/21
DATE.

TITLE:
HU-SL-R Hinge unit, Face Fix, upto 10.8mm glass

NTS
AB
DRAWN.

RH
CHECKED.
REVISION.



Campbell Way
Dinnington
Sheffield
S25 3QD
Tel: 01909 499 899
W: www.granadaglazing.com

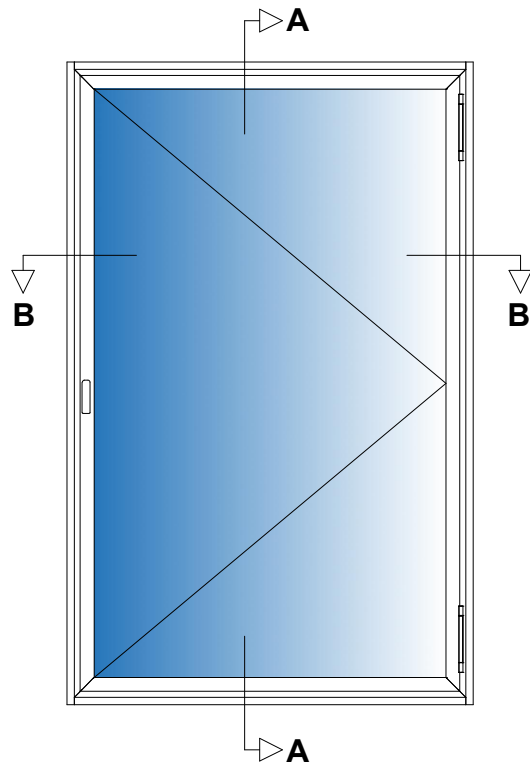

Specification

Aluminium 6063-T6 alloy to BS EN 755-9 standard, powder coated to BS 6496 to 60 - 80 micron finish.

Aluminium Finish: White - RAL 9003 Satin.

Sub-Frame: Primed high quality with 2 coats, FSC Mix credit radiata pine clear grade, FSC mix credit TT-COC-002 157.

Timber Size: 25mm x 16mm.

Glazing: All frames are factory glazed.
(4mm-6.8 single glazed).

Gasket colour: White.

Trim: 27mm uPVC Single Bullnosed White.

Ironmongery: Butt hinges as standard.
Flat pendant handle as standard, locking turnbuckle as a option.

Orientation: Left hand and right hand options.

In line with our company policy of continuous product development and improvement, Granada reserves the right to make minor alterations to specification without notice.

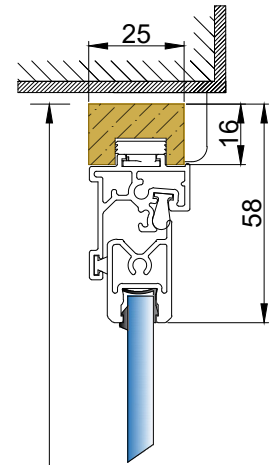

Section A-A

Frame Height

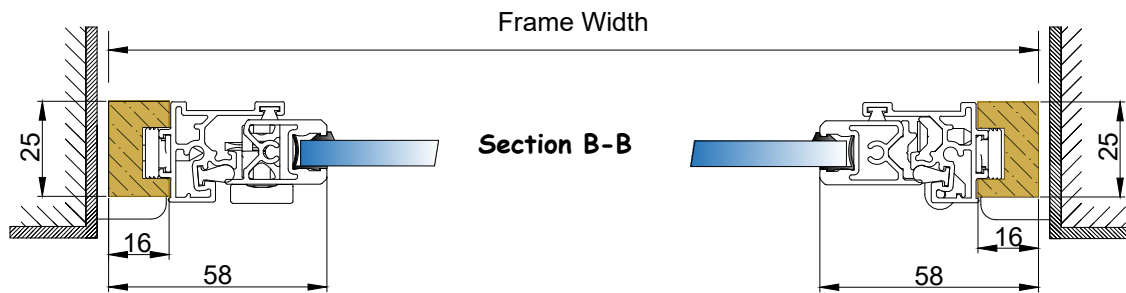
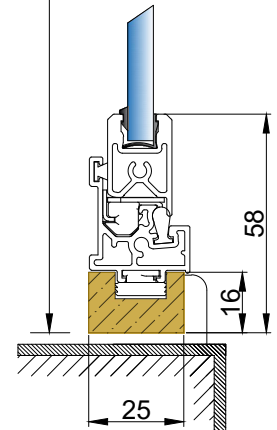

Section B-B

Frame Width

PROJECT:
Standard Details

GSG_001
DRAWING NO.

- PROJECT NO.
07/07/21 DATE.

TITLE:
HU-SL-R Hinge unit, Reveal Fix

NTS
DRAWN.

RH
CHECKED.

-
REVISION.



Campbell Way
Dinnington
Sheffield
S25 3QD
Tel: 01909 499 899
W: www.granadaglazing.com

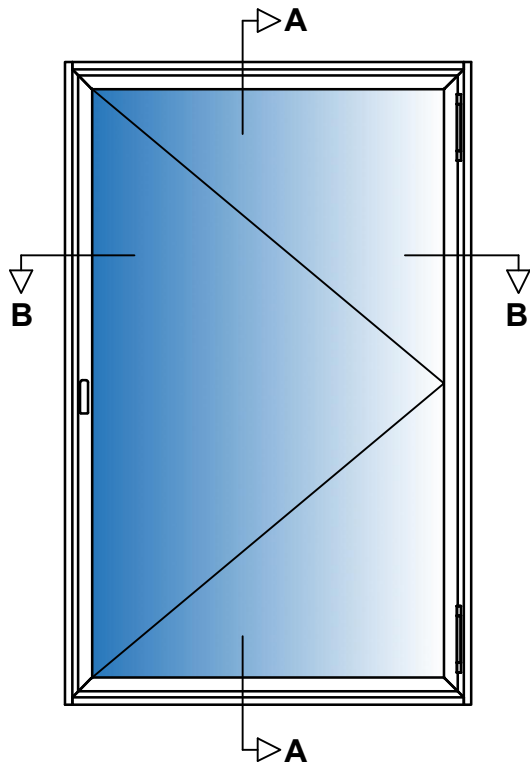

Specification

Aluminium 6063-T6 alloy to BS EN 755-9 standard, powder coated to BS 6496 to 60 - 80 micron finish.

Aluminium Finish: White - RAL 9003 Satin.

Sub-Frame: Primed high quality with 2 coats, FSC Mix credit radiata pine clear grade, FSC mix credit TT-COC-002 157.

Glazing: All frames are factory glazed.
(4mm-6.8 single glazed).

Gasket colour: White.

Trim: 27mm uPVC Single Bullnosed White.

Ironmongery: Butt hinges as standard.
Flat pendant handle as standard, locking turnbuckle as a option.

Orientation: Left hand and right hand options.

In line with our company policy of continuous product development and improvement, Granada reserves the right to make minor alterations to specification without notice.

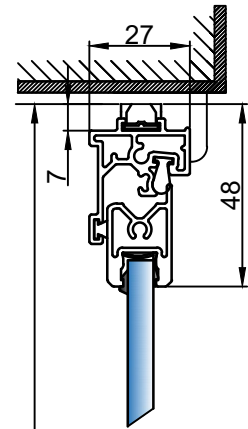

Frame Height

Section A-A

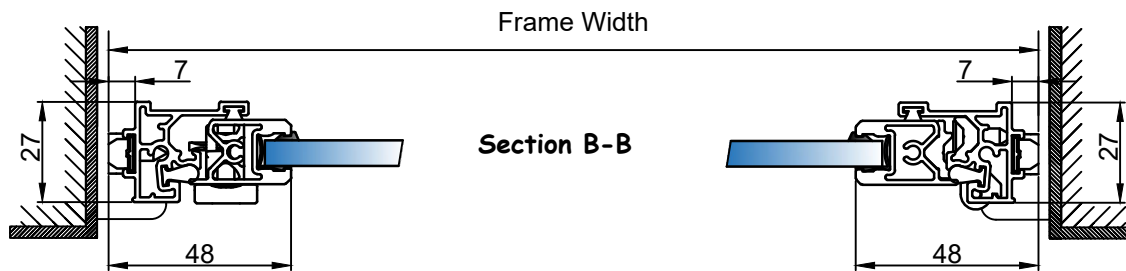
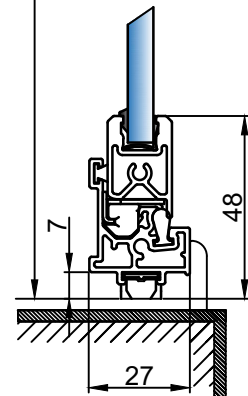

Frame Width

Section B-B

PROJECT:
Standard Details

GSG_001
DRAWING NO.

-
PROJECT NO. DATE.

07/07/21

TITLE:
HU-SL-R Hinge unit, No sub Reveal Fix, up to 6.8mm glass

NTS
AB
DRAWN.

RH
CHECKED.

-
REVISION.



Campbell Way
Dinnington
Sheffield
S25 3QD

Tel: 01909 499 899
W: www.granadaglazing.com

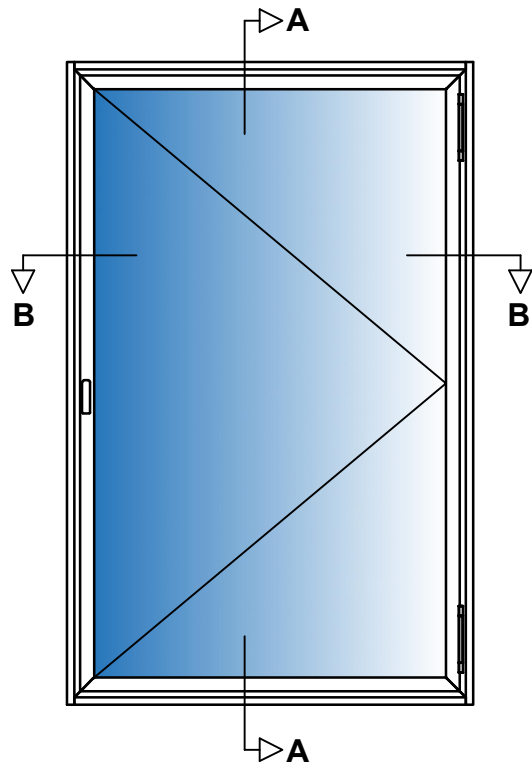

Specification

Aluminium 6063-T6 alloy to BS EN 755-9 standard, powder coated to BS 6496 to 60 - 80 micron finish.

Aluminium Finish: White - RAL 9003 Satin.

Sub-Frame: Primed high quality with 2 coats, FSC Mix credit radiata pine clear grade, FSC mix credit TT-COC-002 157.

Timber Size: 25mm x 16mm.

Glazing: All frames are factory glazed.
(4mm-6.8 single glazed).

Gasket colour: White.

Trim: 27mm uPVC Single Bullnosed White.

Ironmongery: Butt hinges as standard.
Flat pendant handle as standard, locking turnbuckle as a option.

Orientation: Left hand and right hand options.

In line with our company policy of continuous product development and improvement, Granada reserves the right to make minor alterations to specification without notice.

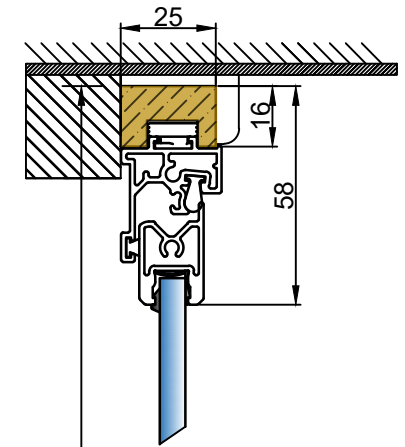

Frame Height

Section A-A

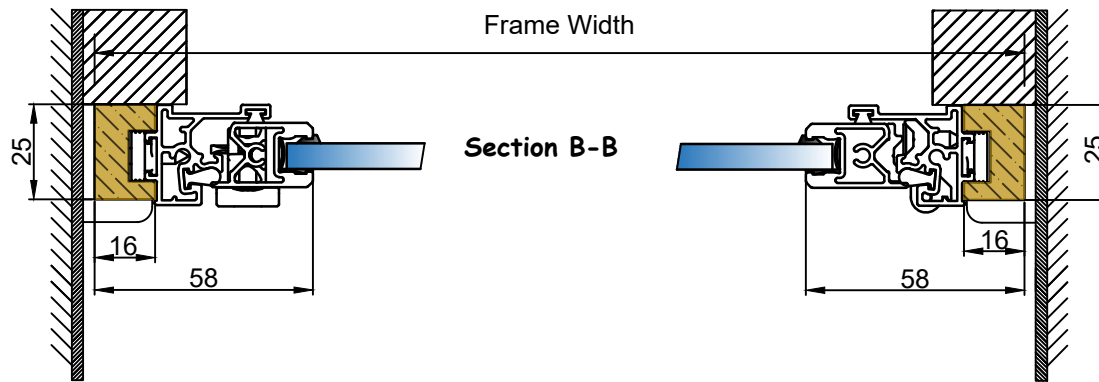

Section B-B

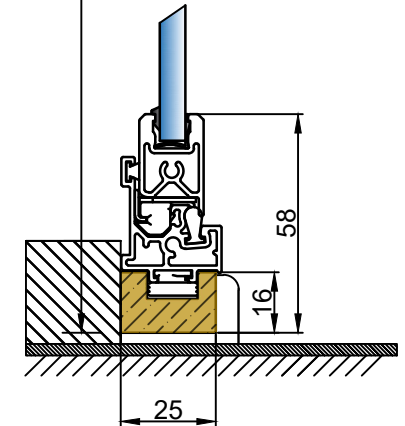

PROJECT:
Standard Details

GSG_001
DRAWING NO.

-
PROJECT NO. DATE.

15/07/21

TITLE:
HU-SL-R Hinge unit, Face Fix, Up to 6.8mm glass

NTS
AB
DRAWN.

RH
CHECKED.

-
REVISION.



Campbell Way
Dinnington
Sheffield
S25 3QD

Tel: 01909 499 899
W: www.granadaglazing.com